

VUE



SIRIUS

User Manual



Please inspect your batteries for any external damage
before charging.

Please make sure you fully charge your batteries
before use.

Do not point at the sun and/or high heat sources.



| | | |
|------------|----------------------------------|----|
| 1. | PRODUCT OVERVIEW | 01 |
| 2. | PRODUCT FEATURES | 01 |
| 3. | PRODUCT DESCRIPTION | 01 |
| 4. | IN THE BOX | 03 |
| 5. | PRODUCT APPEARANCE | 03 |
| 6. | POWER SUPPLY | 04 |
| 7. | BUTTONS OPERATION | 04 |
| 8. | POWER ON / OFF | 08 |
| 9. | MAIN INTERFACE | 08 |
| 10. | SHORTCUT FUNCTION | 09 |
| 11. | SHORTCUT MENU | 10 |
| 12. | ADVANCED MENU | 12 |
| 13. | FIRMWARE UPDATE | 15 |
| 14. | APP DESCRIPTION | 16 |
| 15. | LEGAL AND REGULATORY INFORMATION | 16 |

1. PRODUCT OVERVIEW

SIRIUS series products are easy-to-use, accurate and durable thermal scopes. This series focuses on core functions through minimalist design, making the product easier to use and providing you with value for money. SIRIUS's different heights and 4 direction buttons and intuitive UI make device setting simple and fast. Even wearing gloves in the dark, you can easily identify buttons and operating scopes. Considering the bad weather that may occur in hunting scenes, it is equipped with a high-performance sensor, ultra-large basic magnification to escort the hunting experience of customers in rain/fog/sunny days. Regarding power consumption, the 18650 replaceable battery allows you not to worry about the end of outdoor activities, and the fun is sustainable. In addition, there are RAV functions, PIP functions, waiting for you to experience them in all aspects.

2. PRODUCT FEATURES

- Light weight
- 1024x768 display
- Replaceable 18650 battery
- Magnification: 3.5x-14x(384-35) / 3x-12x(256-19)
- PIP function
- Built-in Wi-Fi module, supporting VUE app connection
- Built-in 32GB storage, photo and video recording available

3. PRODUCT DESCRIPTION

| Model | 256-19 | 384-35 |
|--------------------|--------------|-----------|
| Sensor Type | VOx Uncooled | |
| Sensor Resolution | 256 × 192 | 384 × 288 |
| Sensor Pixel Pitch | 12 μm | |

| Model | 256-19 | 384-35 |
|-----------------------------------|------------------|----------------|
| Sensor NETD | < 25 mk | |
| Sensor Frame Rate | 50 Hz | |
| Objective Lens | 19 mm | 35 mm |
| Optic Zoom | 3 × | 3.5 × |
| Field of View | 8.2 ° | 6.7 ° |
| Linear Field of View | 14.4 yd @100yd | 11.7 yd @100yd |
| Digital Zoom | 1× to 4× | |
| Eye Relief | 42 mm | |
| Diopter Adjustment | -5 D to +5 D | |
| Detection Range | 1000 yd | 1800 yd |
| Display Type | OLED | |
| Display Resolution | 1024 × 768 | |
| WiFi Frequency | 2.4 GHz | |
| Video / Photo Resolution | 1024 × 768 | |
| Video / Photo Format | .mp4 / .jpg | |
| Built-in Memory | 32 GB | |
| Degree of Protection, IP code | IP67 | |
| Operating Temperature Range | -4 °F to +122 °F | |
| Weight | 559g | 599g |
| Dimensions, inch | 8.07x3.03x2.48 | 8.26x3.03x2.48 |
| Battery Type | 18650 | |
| Operating Time | 6 h (at t=72°F) | |
| External Power Supply | 5V (Type-C USB) | |
| Max Recoil Power on Rifled Weapon | 1000 g | |
| Compatible Mounts | Picatinny mount | |

4. IN THE BOX

- The SIRIUS series thermal scope
- Portable bag
- Type-C cable
- Battery charger
- Battery × 2
- Lens cloth
- Thermal target × 5
- Picatinny rail mount
- Hex key
- Hex screw

5. PRODUCT APPEARANCE

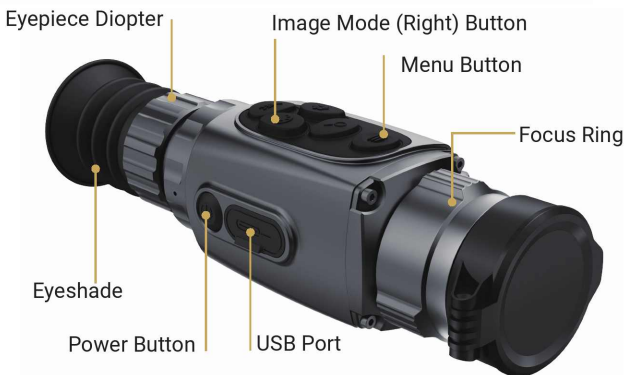

6. POWER SUPPLY

The SIRIUS series is powered by a replaceable 18650 battery(1). Turn the battery cover counterclockwise and remove it. Install the battery into the battery compartment along the special label in the battery compartment designed for it, that is, the positive pole faces inward and the negative pole faces outward.

Close and tighten the battery cover (2) by turning it clockwise.

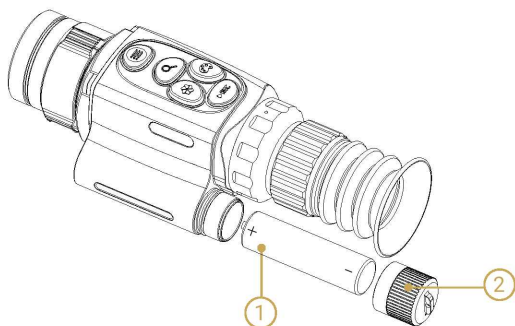

7. BUTTONS OPERATION

| Current status | Button | Press | Press and hold |
|----------------|--------------|-------------------------|-------------------------|
| Shutdown state | POWER button | -- | Power on |
| Standby mode | POWER button | Wake up the device | Wake up the device |
| Main interface | POWER button | Standby | Shutdown |
| | MENU button | Enter the shortcut menu | Enter the Advanced Menu |

| Current status | Button | Short press | Press and hold |
|-------------------------|--------------|---------------------------------------|---------------------------------------|
| Main interface | UP button | Switch electronic / PIP magnification | Turn on / off the PIP function |
| | LEFT button | Image Correction | Environment mode |
| | RIGHT button | Switch image pattern | --- |
| | DOWN button | Record | Photograph |
| Shortcut menu interface | POWER button | Save and return to the main interface | --- |
| | MENU button | Save and return to the main interface | Save and return to the main interface |
| | UP button | Change the image contrast | --- |
| | LEFT button | Change the reticle color | --- |
| | RIGHT button | Change the reticle style | --- |
| | DOWN button | Change the screen brightness | --- |

| Current status | Button | Short press | Press and hold |
|-------------------------|--------------|---|--|
| Advanced menu interface | POWER button | Save and return to the main interface | -- |
| | MENU button | Page 1: Enter page 2 Page 2: Save and exit advanced menu | Save and return to the main interface |
| | UP button | Page 1: Switch Wi-Fi on /off Page 2: Switch RAV on /off | -- |
| | LEFT button | -- | Enter the bad pixel correction interface |
| | RIGHT button | Enter the zeroing interface | -- |
| | DOWN button | Switch the zeroing profiles | -- |
| Zeroing interface | POWER button | A pop-up window will prompt whether to save and then return to the main interface | -- |
| | MENU button | Freeze / Restore | Save and return to the main interface |

| Current status | Button | Short press | Press and hold |
|--------------------------------|--------------|---|---------------------------------------|
| Zeroing interface | UP button | Move coordinates up | Move coordinates up quickly |
| | LEFT button | Move coordinates left | Move coordinates left quickly |
| | RIGHT button | Move coordinates right | Move coordinates right quickly |
| | DOWN button | Move coordinates down | Move coordinates down quickly |
| Bad pixel correction interface | POWER button | A pop-up window will prompt whether to save and then return to the main | -- |
| | MENU button | Confirm / Cancel bad pixel | Save and return to the main interface |
| | UP button | Move coordinates up | Move coordinates up quickly |
| | LEFT button | Move coordinates left | Move coordinates left quickly |
| | RIGHT button | Move coordinates right | Move coordinates right quickly |
| | DOWN button | Move coordinates down | Move coordinates down quickly |

8. POWER ON / OFF

Power On / Starting

The device is in shutdown state:

Press and hold the POWER button for 3 seconds to turn on scope. The VUE logo will appear.

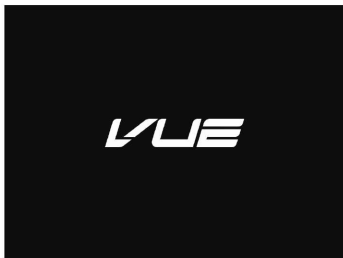

Powering Off / Stopping

The device is in power-on state:

Press and hold the POWER button, the power-off screen will open, start counting, shut down after 3s.

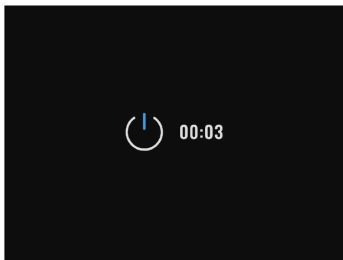

Tips: If you release the POWER button within 3 seconds, the shutdown process will stop and it will return to the main interface.

9. MAIN INTERFACE

Status Bar

The status bar is in the upper left corner of the main interface. The icons correspond to the following functions:

1. Environment mode: Sun/Fog.
2. Digital zoom: 1x 2x 4x.
3. Wi-Fi: On/Off.
4. Current zeroing profile : A/B/C/D/E.

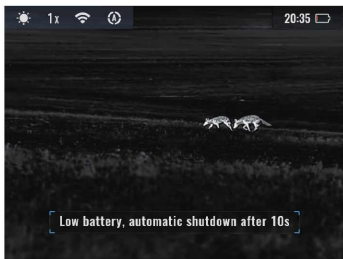

Time And Battery

The time and battery information are displayed in the upper right corner of the main interface.

1. Real-time time.
2. Battery level: The 4 power levels are 10%, 40%, 70%, and 100%. The USB charging status icon is displayed when charging.

10. SHORTCUT FUNCTION

Digital Zoom

On the main interface, press the UP button to zoom image. The magnification factors are 1X, 2X, and 4X. The top status bar is updated in real time.

PIP

On the main interface, press and hold the UP button to enable the PIP function. When the PIP function is turned on, the PIP displayed in the upper center of the screen, the small dot in the center indicates the center position of the reticle. At this time, press the UP button to switch the PIP magnification. The original image will maintain a x1 magnification.



Image Correction

On the main interface, press the LEFT button to perform an image correction. This is usually used when the image effect is poor.

Environment Mode Switching

On the main interface, press and hold the LEFT button to switch environment mode between sun and fog.

Image Pattern Switching

On the main interface, press the RIGHT button to switch the image pattern, including white hot, black hot, red hot, color, red monochrome.



Recording

On the main interface, press the DOWN button to start recording, the timer will be displayed at the top of the screen, with a time format of MM:SS (minute: second). If the memory is full, an exclamation mark will appear at the top of the screen, and a text prompt will appear below. Press the DOWN button again to stop and save the recording.



Photographing

On the main interface, press and hold the DOWN button to take a photo.



11. SHORTCUT MENU

On the main interface, press the MENU button to open the shortcut menu. Short press the UP, DOWN, LEFT, and RIGHT buttons to adjust the specific parameters of the menu function.

Press and hold the MENU button or press the POWER button to save the changes and return to the main interface. If there is no operation for 5 seconds, the shortcut menu will automatically exit. Any changes in the shortcut menu will be saved when exiting, including shutdown operation.

Contrast Setting

On the shortcut menu interface, press the UP button to switch contrast, with a range of 1-5.

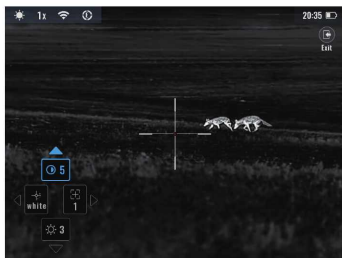

Screen Brightness Setting

On the shortcut menu interface, press the DOWN button to switch screen brightness, with a range of 1-5.

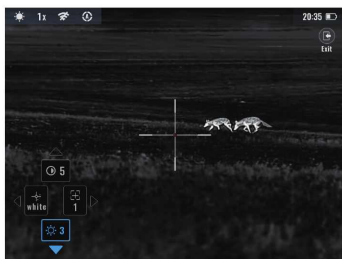

Reticle Color Setting

On the shortcut menu interface, press the LEFT button to switch reticle color, and choose from white, black, red, and green.

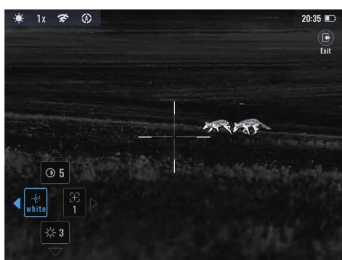

Reticle Type Settings

On the shortcut menu interface, press the RIGHT button to switch reticle type, with a total of 8 reticle type options available.

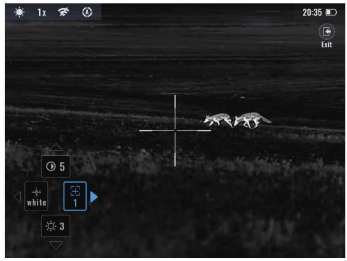

12. ADVANCED MENU

On the main interface, press and hold the MENU button to open the advanced menu.

On the page 1 of advanced menu, press MENU button to switch to the page 2.

Press MENU button on the page 2 to exit the advanced menu.

Press the UP, DOWN, LEFT, and RIGHT buttons to adjust the menu function parameters.

Press and hold the MENU button or press the POWER button to save the changes and return to the main interface.

If there is no button operation for 30 seconds, the advanced menu will automatically exit.

The system information is displayed on the lower right corner on page 2.



Wi-Fi Setting

On the advanced menu interface, press the UP button to turn on or off the Wi-Fi function.

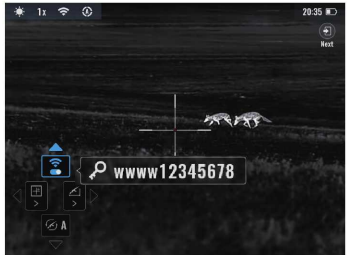

Switching Zeroing Profiles

On the advanced menu interface, press the DOWN button to switch zeroing data group, range from A to E.

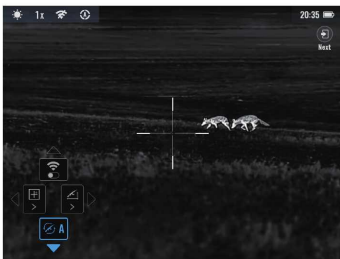

Bad Pixel Correction

On the page 1 of the advanced menu interface, press and hold the LEFT button to enter the bad pixel correction interface. Press the UP, DOWN, LEFT, and RIGHT buttons to move the reticle, and press the MENU button to confirm/cancel the current coordinate.

After the correction is completed, press and hold the MENU button to save and exit.

You can also press the POWER button, a window will pop up to prompt whether to save. At this time, if you press the UP button, save and exit (the interface prompts that the bad pixels data has been saved successfully), if you press the DOWN button, do not save and exit (the interface prompts that the bad pixels data has not been saved).

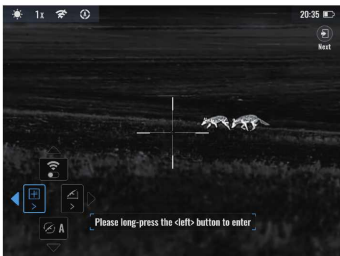

Zeroing

On the advanced menu interface, press the RIGHT button to enter the zeroing interface.

After entering the zeroing interface, press the MENU button to freeze the image.

Then short or long press the UP, DOWN, LEFT, and RIGHT buttons to move the reticle.

When the reticle is aligned with the point of impact, press and hold the MENU button to save and exit.

You can also press the POWER button, a window will pop up to prompt whether to save. Press the UP button to exit with saving or the DOWN button to exit without saving.

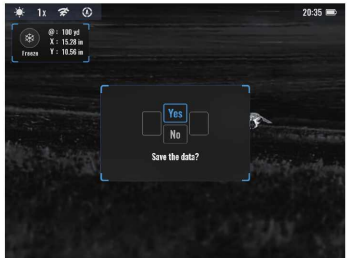
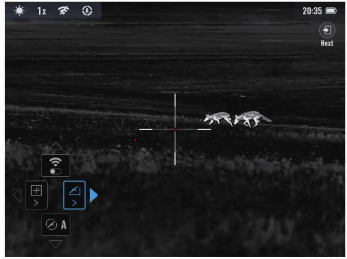

Recoil Activated Video

On the second page advanced menu interface, press the UP button to turn on or off the RAV function (recoil activated video function).

Press the DOWN button to stop recording when recording.

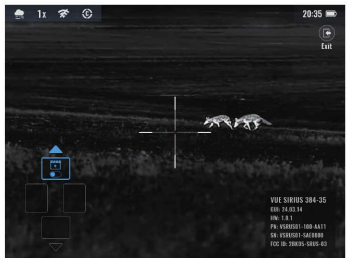

13. FIRMWARE UPDATE

Copy the firmware file to device.

Press and hold the Power button to turn off, it then detects the firmware file and upgrades.

14. APP DESCRIPTION

The SIRIUS series comes with a dedicated app. By connecting the device to the app on a mobile phone, tablet, or laptop you can enjoy real-time image transmission, perform device operations, and receive program updates. Search 'VUE' in the Apple Store or Google Play Store to install.

15. LEGAL AND REGULATORY INFORMATION

EU/UK Compliance Statement

Frequency range of WLAN radio module: 2.412-2.472GHz

WLAN radio module power < 20dBm



We, Essence Outdoors LLC, hereby declares that the radio equipment types SIRIUS series is in compliance with the Directives 2014/53/EU and 2011/65/EU.

Disposal of batteries



2023/1542 (Battery Regulation): This product contains a battery that cannot be disposed of as unsorted municipal waste in the European Union. For battery details, refer to the documentation of the specific product. The battery is marked with this symbol, which may include Cd (indicating cadmium), Pb (indicating lead), or Hg (indicating mercury). For proper recycling, please return the battery to your supplier or send it to a designated collection point. For more information, visit www.recyclethis.info.

User information on the disposal of electrical and electronic devices (private households)



2012/19/EU (WEEE directive): Products marked with this symbol cannot be disposed of as unsorted municipal waste in the European Union. For proper recycling, return this product to your local supplier upon the purchase of equivalent new equipment, or dispose of it at designated collection points. For more information see: www.recyclethis.info.

FCC Statement

FCC ID: 2BKD5-SRUS-03

Labeling Requirements

This device complies with part 15 of the FCC Rules. Operation is subject to the following two conditions: (1) This device may not cause harmful interference, and (2) this device must accept any interference received, including interference that may cause undesired operation.

Information To The User

Any Changes or modifications not expressly approved by the party responsible for compliance could void the user's authority to operate the equipment.

EMC Class A

Note: This equipment has been tested and found to comply with the limits for a Class A digital device, pursuant to part 15 of the FCC Rules. These limits are designed to provide reasonable protection against harmful interference when the equipment is operated in a commercial environment. This equipment generates, uses, and can radiate radio frequency energy and, if not installed and used in accordance with the instruction manual, may cause harmful interference to radio communications. Operation of this equipment in a residential area is likely to cause

harmful interference in which case the user will be required to correct the interference at his own expense.

To comply with RF exposure requirements, a minimum separation distance of 0.00 cm must be maintained between the user's body and the handset, including the antenna.

Company:
Essence Outdoors LLC

Email:
info@essence-outdoors.com

Addr. :
8101 Boat Club Rd Ste 240
PMB 619, Fort Worth, 76179,
TX, US